

Hydraulic

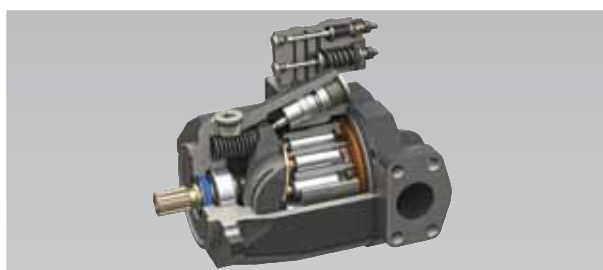

HEMA PUMPS

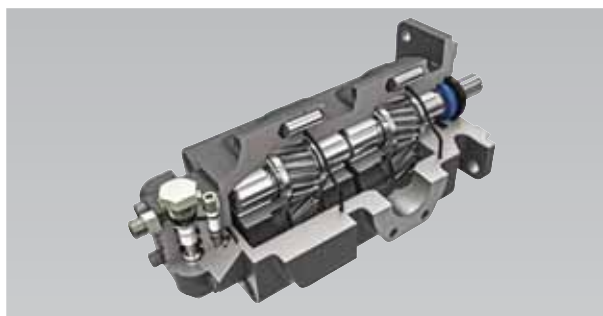

Aluminum Body Pump					
Group	Series	Gear Type	Displacement (cm ³ /rev)	Max. Outlet Pressure (bar)	Max. Speed (RPM)
Group-1	0.5P	Spur	1.1 - 7.5	170	4000
N/A	0P1	Spur	1.2 - 8.1	280	4000
Group-2	1PA	Spur	4.0 - 22.9	175	3500
Group-2	1PN	Spur	4.0 - 28.1	250	4000
Group-2.5	1.5P	Spur	16.7 - 56.1	210	3000
Group-2.5	1.5PN	Spur	16 - 41	230	3000
Group-3	2P1	Spur	16.7 - 56.1	250	3000
Group-3	2PN	Spur	23 - 63	250	3000
Group-3.5	3P1	Spur	47 - 116.7	250	2250
	1PH	Helical	8.2 - 28.1	250	4000
	1PS	Spur (Silent)	4.0 - 31.0	250	4000
	1.5PH	Helical	16.0 - 40.6	210	3000

Cast Iron Body Pump				
Series	Gear Type	Displacement (cm ³ /rev)	Max. Outlet Pressure (bar)	Max. Speed (RPM)
QR4	Spur	16 - 60	250	3000
QR5	Spur	45 - 120	250	3000
QR6	Spur	100 - 220	250	2750
QS4	Helical	16 - 40.6	250	3000
QS5	Helical	43.5 - 82.2	250	3000
QS6	Helical	80.3 - 149.9	250	2750
QS7	Helical	149.9 - 239.8	250	2400
QX5	Helical	23 - 68	250	3000
1600	Spur	12.38 - 41.30	170	2700
1900	Spur	22.0 - 74.2	210	2700
2200	Spur	53.6 - 110.8	210	2700
1CP1	Spur	16 - 41	276	3000
1CP2	Spur	7 - 45.1	276	3000
1CP3	Spur	23 - 73	280	3000

Variable Displacement Axial Piston Pump				
Series	Displacement (cm ³ /rev)	Max. Outlet Pressure (bar)	Peak Pressure (bar)	Max. Speed (RPM)
EPP Series Type A	28	260	320	2700
	35	260	320	2700
	45	260	320	2700
EPP Series Type B	65	280	350	2200
	75	280	350	2200
EPP Series Type C	45	260	320	2500
	63	260	320	2500

Control Type	EPP Series Type A	EPP Series Type B	EPP Series Type C
Pressure regulation	✓	✓	✓
Pressure and flow regulation	✓	✓	✓
Electro - Hydraulic pressure control	✓	✓	✓
Pressure, flow and power regulation		✓	
Pressure, flow and power regulation (With solenoid control)		✓	

Please consult Hema Endustri A.S. for different options



HEMA PUMPS



Transmission Oil Pumps

- Power-shift transmission pumps with spur gear or gerotor design.
- Min-Max speed 600-3000 RPM, 5 to 30 bar

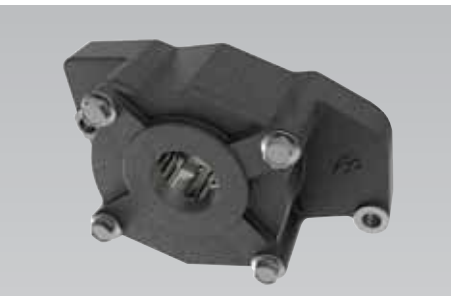

Engine Oil Pumps

- Engine oil pumps with spur gear and gerotor types.
- Design, manufacturing and validation test capability up to 400 HP diesel engines

HEMA MOTORS



Aluminum Body Motors

Series	Displacement (cm ³ /rev)	Max. Pressure (bar)	Max. Speed (RPM)
1MN	6.1 - 26	250	4000
1.5MN	16 - 30	250	3000
2MN	23 - 73	280	3000

Cast Iron Body Motors

Series	Displacement (cm ³ /rev)	Max. pressure (bar)	Max. Speed (RPM)
1600	12.38 - 41.30	170	3000
1900	22.0 - 74.2	210	3000
2200	53.6 - 110.8	210	3000

Orbital Motors

Series	CMP Gerotor		CMR Geroller	
	Displacement (cm ³ /rev)	51.7 ... 401.9	51.7 ... 401.9	51.7 ... 401.9
Max. Speed (RPM)	Continuous	900 ... 160	775 ... 160	775 ... 160
	Intermittent	1050 ... 195	940 ... 200	940 ... 200
Max. Torque (Nm)	Continuous	78 ... 334	95 ... 380	95 ... 380
	Intermittent	105 ... 429	120 ... 470	120 ... 470
	Peak	130 ... 537	135 ... 540	135 ... 540
Max. Pressure (bar)	Continuous	125 ... 70	140 ... 70	140 ... 70
	Intermittent	165 ... 90	175 ... 90	175 ... 90
	Peak	200 ... 110	200 ... 110	200 ... 110

Please consult Hema Endustri A.S. for different options



HEMA VALVES

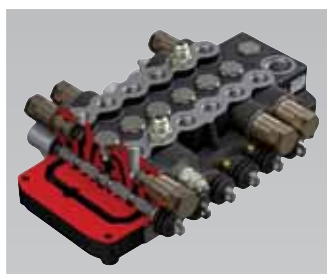
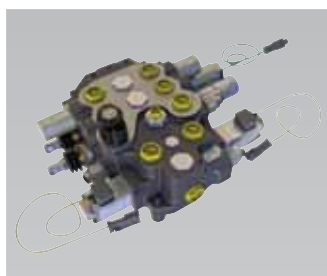

Monoblock Directional Control Valves - Open Center

Series	Flow Rate (l/min)	Pressure (bar)	Spools Nr. Of	Circuit	Manual	Pilot	Solenoid
MV023	30	250	3	Parallel	X		X
MV024	30	250	2, 3, 4	Parallel	X		
MV026	30	250	2, 3, 4	Parallel	X		
MV027	30	250	1	Parallel	X	X	X
MV045	50	280	1, 2, 3	Parallel	X		
MV046	50	280	3, 4	Parallel	X		
MV051	50	280	2, 3, 4	Parallel	X		
MV052	50	280	2, 3, 4	Parallel	X		
MV053	60	250	2, 2+1	Parallel	X		
MV055	60	250	2	Series	X		
MV061	80	250	2	Parallel	X		
033	150	230	6, 6+1, 6+2	Parallel	X	X	
034	150	230	2, 3	Parallel	X	X	X
035	150	230	2, 3	Parallel	X	X	X
MV180	180	250	6	Parallel	X	X	
MV181	180	250	3	Parallel	X	X	X
MV182	180	250	1	Parallel	X	X	
4009	205	210	1, 2, 3	Tandem	X	X	
4109	205	210	1, 2, 3, 4, 5	Parallel	X	X	
4011	270	230	1, 2, 3	Tandem	X	X	X
MV059	375	250	3	Tandem		X	
4013	450	230	1, 2, 3	Tandem	X	X	X

Sectional Directional Control Valves - Open Center

Series	Flow Rate (l/min)	Pressure (bar)	Nr. Of Sections	Circuit	Manual	Pilot	Solenoid
MV060	60	250	1 - 5	Parallel	X	X	X
MV050	80	280	1 - 9	Parallel	X	X	X
MV090	100	280	1 - 9	Parallel	X	X	X
SV033	150	250	1 - 10	Parallel Tandem Series	X	X	X

Sectional Directional Control Valves - Closed Center

Series	Flow Rate (l/min)	Pressure (bar)	Nr. Of Sections	Circuit	Manual	Pilot	Solenoid
MV183	180	250	1 - 10	Parallel	X	X	X

Please consult Hema Endustri A.S. for different options

HEMA TRANSMISSION VALVES

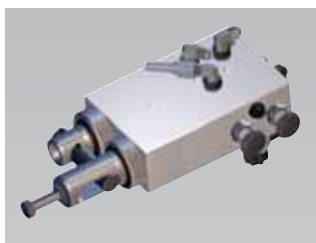

Model	Description	Features	
DV016	Four wheel drive & differential lock valve (DT/DL valve)	Adjusted outlet pressure	17 bar
		1. On/off solenoid	Differential lock
		2. On/off Solenoid	Four wheel drive
DV018	Four wheel drive & differential lock valve (DT/DL valve)	Adjusted outlet pressure	19 bar
		1. On/off solenoid	Differential lock
		2. On/off solenoid	Four wheel drive
DV019	Transmission control valve	Adjusted outlet pressure	14-15 bar
		1. On/off solenoid	Differential lock
		2. On/off solenoid	Four wheel drive
		3. On/off solenoid	Power take off
DV103	Transmission control valve	Adjusted outlet pressure	18-20 bar
		1. On/off solenoid	Four wheel drive
		2. On/off solenoid	Differential lock
		3. Proportional solenoid	Forward
		4. Proportional solenoid	Reverse
		5. Proportional solenoid	Power take off
		6. Proportional solenoid	Second speed
		7. On/off solenoid	Hand brake
ODV200	Clutch control valve	Min. working flow rate	13 LPM
		Max. working flow rate	40 LPM
		Adjusted outlet pressure	18 bar
KMV201	PTO control valve	Min. working flow rate	13 LPM
		Max. working flow rate	40 LPM
		Adjusted outlet pressure	18 bar

HEMA AUXILIARY VALVES



Model	Description	Features	
OV100	Priority valve with load sense	Nominal flow rate	80 LPM
		Max. inlet pressure	250 bar
		Controlled pressure difference	6 bar
BV080	Baler gate valve	Max. Flow rate	75 LPM
		Max. Operating pressure	207 var
UV07	Line mounted unloader valve	Nominal flow rate	135 LPM
SSV09	Diverter Valve	Nominal flow rate	200 LPM
		Diverting type	1 -> 1 of 2
DSV06	Diverter Valve	Nominal flow rate	68 LPM
		Diverting type	2 -> 2 of 4
DSV059	Diverter Valve	Nominal flow rate	200 LPM
		Diverting type	2 -> 2 of 4
DSV11	Diverter Valve	Nominal flow rate	200 LPM
		Diverting type	2 -> 2 of 4



HEMA LIFTS

Hydraulic lift is a lifting system located at the rear of tractors. Consist of a housing mounted on transmission case, lifting arms, main shaft, crank arm, connecting rod, cylinder, piston and control valve. Implement is mounted on hydraulic lift arms by using three using three point linkage.

- Hema hydraulic power lifts are available for tractors which have engines from 18 HP to 140 HP
- Hydraulic and electronic power lifts with position control, draft control and mix control
- Rate of drop/lock valve for locking and controlled lowering
- Electronically controlled hydraulic power lift has been designed and produced to offer a high performance, ease of use and reliability.

Model	Tractor engine power (HP)	Circuit	Lift capacity (at lower links) (kg)	Max. flow rate (LPM)	Max. working pressure (bar)	Position control	Draft control	Mix control	Autolift	Rate of drop	Auto adjustable lowering speed	EH Control	On/Off or load sense control valve
HK402	20 - 60	Open	1200	45 (EH:100)	172	✓				✓		OPT	
HK451	30 - 80	Open	1510	45	195	✓				✓			
HK453	30 - 80	Open	1510	45	195	✓	✓	✓	OPT	✓			
HK240	35 - 60	Open	1600	25	235	✓	✓	✓		OPT			
HK290													
HK546	40 - 80	Open	1780	45	195	✓	✓	✓	✓	✓			
HK038	45 - 70	Open	2200	65	195	✓	✓	✓	✓	✓	OPT	OPT	OPT
HK036	45 - 55	Open	1300	65	195	✓	✓	✓	✓	✓	OPT	OPT	OPT
HK039	50 - 75	Open	2300	65	195	✓	✓	✓	✓	OPT	✓	OPT	OPT
HK065	50 - 80	Open	2400	65	195	✓	✓	✓	✓	✓	OPT	OPT	OPT
HK080	50 - 80	Open	3200	65 (EH:100)	195	✓	✓	✓	✓	✓	OPT	OPT	OPT
HK035	55 - 75	Open	3000	65	195	✓	✓	✓	✓	OPT	✓	OPT	OPT
HK037	55 - 75	Open	2200	65	195	✓	✓	✓		✓	✓	OPT	OPT
HK060	60 - 90	Open	2700	65	195	✓	✓	✓	✓	✓	OPT	OPT	OPT
HK780	60 - 95	Open	2600	65	195	✓	✓	✓		✓	OPT	OPT	OPT
HK3075	75 - 90	Open	3750	45	250	✓	✓	✓		✓		OPT	
HK3105													
HK102	90 - 110	Open	4400	65 (EH:100)	195	✓	✓	✓	✓	✓	OPT	OPT	OPT
HK104	120- 140	Open	7750	100	195	✓	✓	✓	✓			✓	
JD1000	18 - 25	Open	300	14	138	✓				✓			
JD4000	30 - 65	Open	900	45 (EH:100)	172	✓				✓		OPT	
JD5000	58 - 78	Closed	2200	75	195	✓	✓	✓		✓			
H001	75 - 95	Open	3300	55 (EH:100)	195	✓	✓	✓	✓	✓		OPT	
T275	75 - 102	Open	2600	100	195	✓	✓	✓	✓	✓		✓	
JD6000	90 - 120	Closed	4100	96	195	✓	✓	✓		✓			





HEMA LIFT CONTROL VALVES

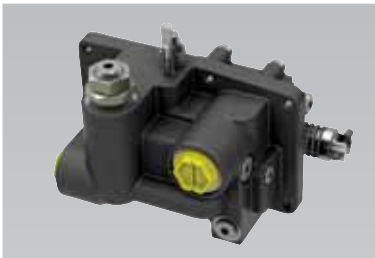
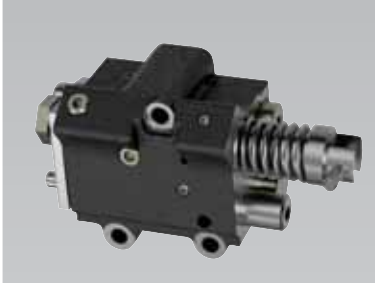

Model	Hydraulic System	Max Working Pressure (bar)	Max Rated Flow (LPM)	Relief Valve Pressure (bar)	Surge Relief	Rate of Drop Valve
KV350	Open Circuit	200	35	-	-	-
KV400	Open Circuit	200	45	-	-	-
KV450	Open Circuit	200	70	-	230 ±5	✓
KV500	Open Circuit	200	75	-	-	-
KV500-Manifold	Closed Circuit	200	75	195 ±5	235 ±5	✓
KV600	Closed Circuit	200	80	195 ±5	240 ±5	✓

Electro-Hydraulic Hitch Control System

Electro-hydraulic lift control valve is designed to control the three point hitch system on tractors. The system consist of lift hitch control valve with proportional solenoids, electronic control unit, control panel (with switch and lever options), Load and position sensors.



Features	
Single acting cylinder, open or closed center hydraulic system	
Technical Data	
Max. permissible pressure	A: 220 bar, R: 5 bar.
Max. rated flow	100 LPM
Leakage	1 cc/min @180 bar with 23cSt oil
Port connections	M22x1.5 internal thread
Hydraulic fluid	Mineral oil to DIN/ISO
Operating temperature	- 30...100°C
Recommended viscosity	20.....100cSt
Electrical connection	AMP828657-3
Protection factor	IP67
Operation type	Proportional solenoid 12V, 2.4A

ABOUT US

HEMA was established in 1973 under the name of “Hema Hidrolik Makine Sanayi ve Ticaret A.S” located in the Cerkezkoy Industrial Zone in the Tekirdag region to produce external gear pumps for Turkish Industries needs. Over the years HEMA Endüstri has extended product range and industries it serves. Today as one of the leading engineering and manufacturing companies in Turkey, supplies systems and components to automotive, agricultural and construction equipment OEMs with additional divisions serving the mining,

In 1998 the company name was changed to HEMA Endüstri A.S. to reflect the breadth of the company activities. Competing with leading manufacturers of the world, Hema continuously aims new technological capabilities in order to improve its product quality and efficiency. Giving particular importance to quality and customer satisfaction, Hema has over the years become a major OEM supplier in the industries that it serves.

Hema owns well-trained, qualified and experienced 3000 strong workforce which fuels its growth and achievements



Factory in TURKEY

G.O.P Mah. (OSB) 4. Cadde No:5
59500 Cerkezkoy/Tekirdag/TURKEY

Tel : +90 (282) 758 1040

Fax : +90 (282) 758 1071

Email: marketing@hattat.com.tr

Istanbul Head Office

Büyükdere Cad. No:235 34398

Maslak/Istanbul/TURKEY

Tel : +90 212 285 2240

Fax : +90 212 286 4455

Factory in INDIA

Hema Driveline & Hydraulics Pvt. Ltd.

Plot No: PAP V-103/5 MIDC Phase II

Chakan Industrial Area Wasuli

Chakan / Pune 410501

Tel : +91 213 569 0046

Fax : +91 213 569 99 47

Office in USA

Hema Driveline and Hydraulics Inc.

2800 Lively Blvd, Elk Grove Village

IL 60007 USA

Tel : +1 (847) 737 1862

Fax : +1 (847) 430 4803

Email : hemausa@hattat.com.tr

Office in CHINA

JunShangJinZuo No : 229 / 501

Tongjiang St. Binsheng Avenue,

Binjiang Area, Hangzhou City,

Zhejiang Province

Tel : +86 571 8657